

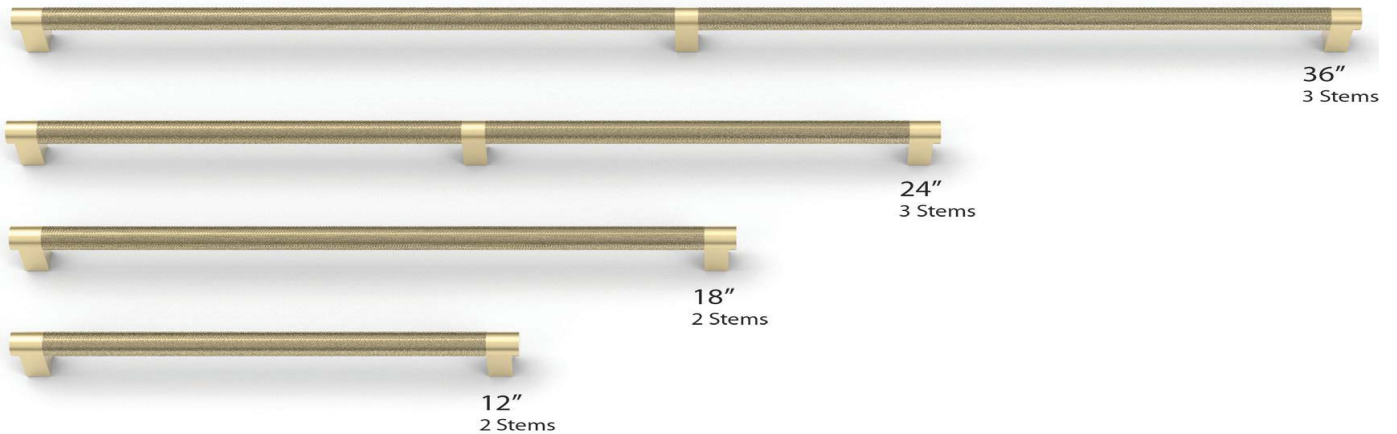









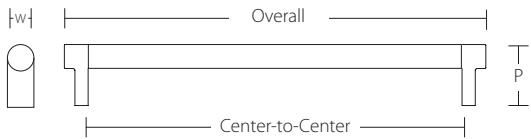

SELECT APPLIANCE PULLS

Technical Specifications

EMTEK®



SELECT APPLIANCE PULL						Stem	Bar Pull
Optional Mounting	Product Code	C-to-C	Overall	Width(W)	Projection(P)	 RECTANGULAR (REC)	 KNURLED (KN)  SMOOTH (SM)
CS or BTB	84070	12"	12 7/8"	1"	2"		
CS or BTB	84071	18"	18 7/8"	1"	2"		
CS or BTB	84072	24"	24 7/8"	1"	2"		
CS or BTB	84073	36"	36 7/8"	1"	2"		
						STEM AND BAR PULL WILL BE PERMANENTLY AFFIXED.	
FINISH OPTIONS FOR STEM AND BAR PULL							
							
Satin Brass (US4)	Oil Rubbed Bronze (US10B)	Polished Nickel (US14)	Satin Nickel (US15)	Flat Black (US19)	Polished Chrome (US26)	Satin Copper (SCU)	

To order: **CS/BTB 84070 . RECUS4 . KNUS19**

Optional Mounting Product Code (Center-to-Center) + Stem (Style/Finish) + Bar Pull (Style/Finish)

