

EMTOUCH™

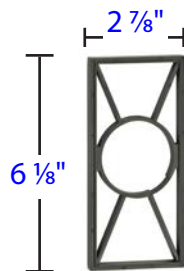
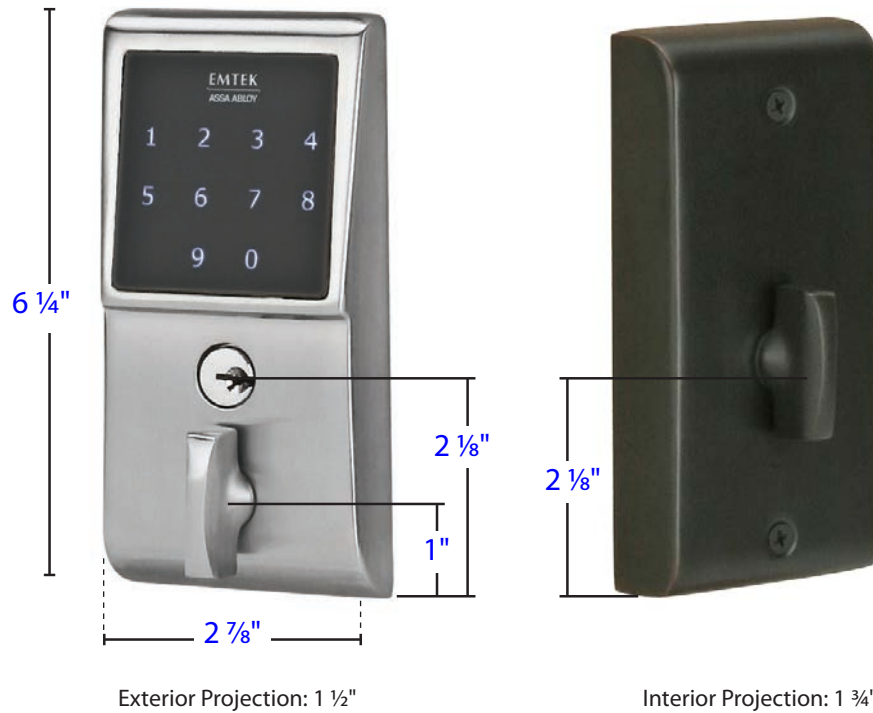

Adaptors available for leversets to fit doors between 1 3/8" and 1 5/8" thick.

Product Features:

- Fits any door between 1 3/4" to 2 1/4" thick with a 2 1/8" bore standard door prep.
- Installs easily with only a Phillips head screwdriver.
- Easy to use installation and programming instructions included.
- Factory programmed with 2 unique, secure user codes for use right out of the box.
- Can be programmed with up to 20 user codes of your choice.
- Codes can be added and deleted.
- Easy lock operation, simply push the Emtek button and turn the exterior thumb turn to lock.
- Easy unlock operation, enter the 4 digit code and turn the exterior thumb turn.
- Programming changes can be made easily using the keypad.
- Sleek keypad has a protective coating to prevent wear patterns.
- Illuminated keypad for easy and quick operation after dark.
- Low battery indicator lets you know when it's time to change the battery.
- Emtek's standard mechanical and finish warranties along with a 2 year warranty on electronic components.

EMTOUCH™



Exterior Projection: 3"

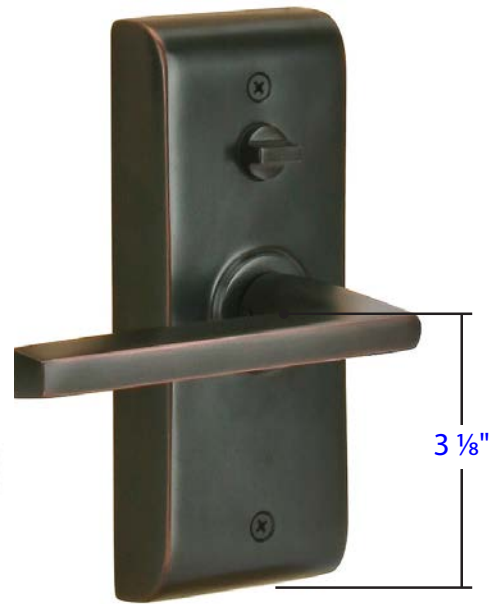

Interior Projection: 3"

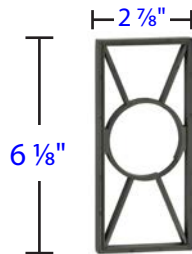

Adaptors available for leversets to fit doors between 1 3/8" and 1 5/8" thick.



Passage Function
Shown in Passage
Mode

Storeroom/Gate
Function



- Storeroom / Gate Function**
- Outside lever always locked
 - Entry by code or key only
 - Inside lever always free



Passage Function in Locked Mode

- Outside lever always locked
- Entry by code or key only
- Inside lever always free



Passage Function in Passage Mode

- Outside lever always free
- Entry by operating lever, no code or key required.
- Inside lever always free

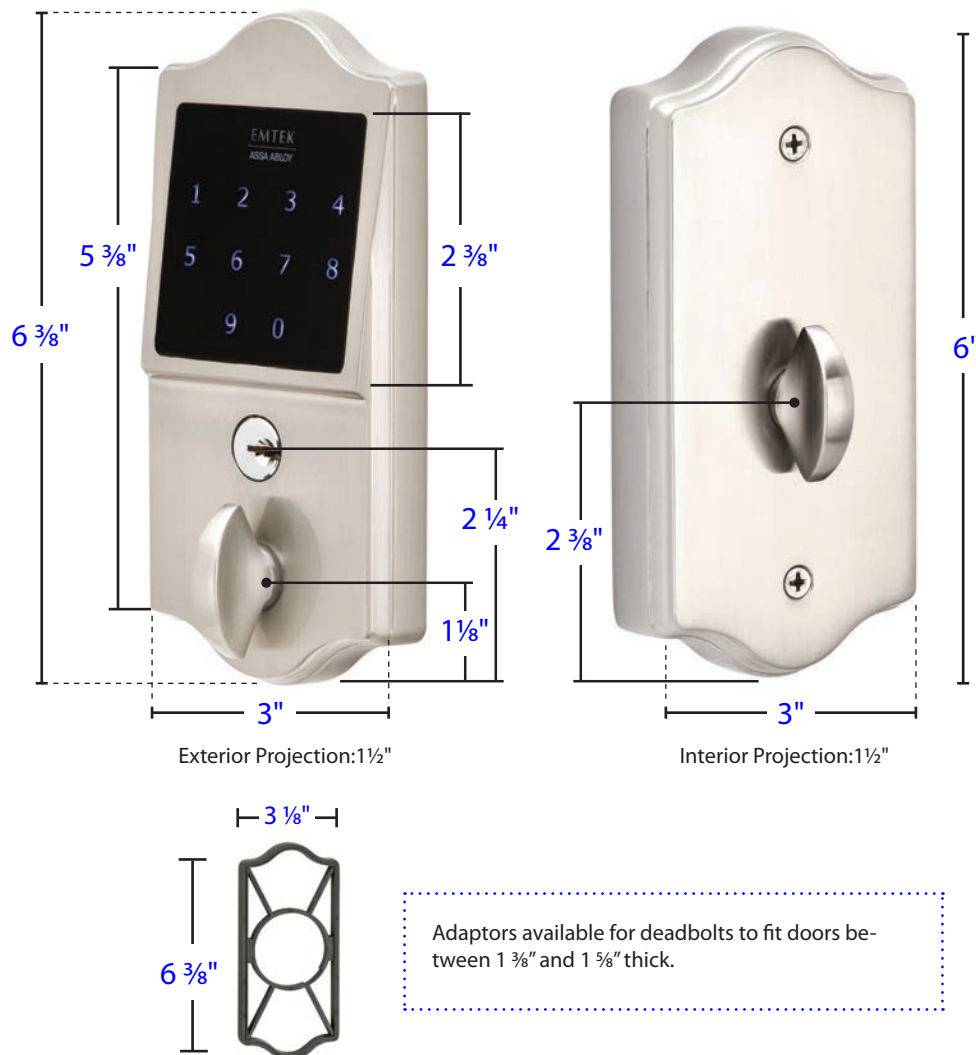
EMTOUCH™ CLASSIC

Product Features:

- Fits any door between 1 3/4" to 2 1/4" thick with a 2 1/8" bore standard door prep.
- Installs easily with only a Phillips head screwdriver.
- Easy to use installation and programming instructions included.
- Factory programmed with 2 unique, secure user codes for use right out of the box.
- Can be programmed with up to 20 user codes of your choice.
- Codes can be added and deleted.
- Easy lock operation, simply push the Emtek button and turn the exterior thumb turn to lock.
- Easy unlock operation, enter the 4 digit code and turn the exterior thumb turn.
- Programming changes can be made easily using the keypad.
- Sleek keypad has a protective coating to prevent wear patterns.
- Illuminated keypad for easy and quick operation after dark.
- Low battery indicator lets you know when it's time to change the battery.
- Emtek's standard mechanical and finish warranties along with a 2 year warranty on electronic components.

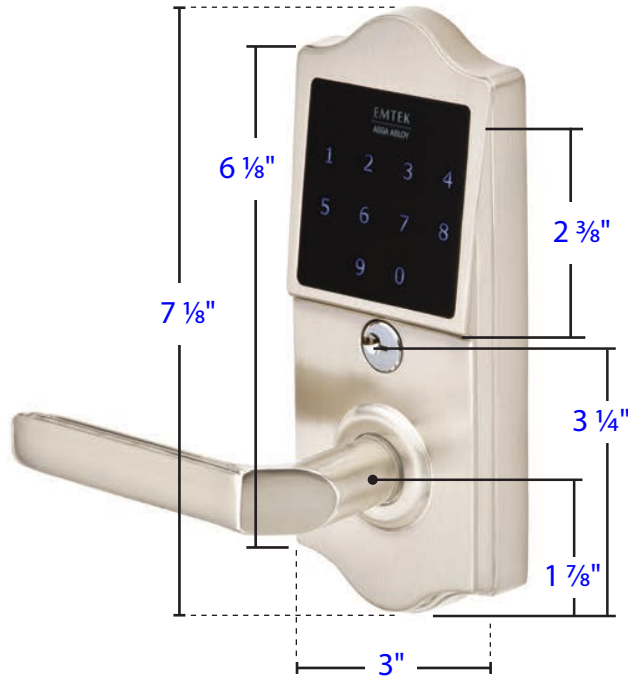
EMTOUCH™ CLASSIC

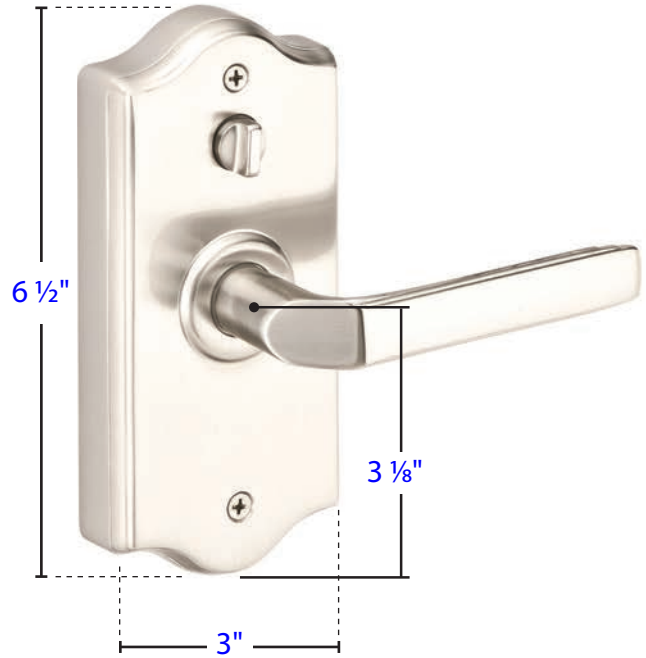

Exterior Projection: 3 1/4"



Interior Projection: 3 1/8"

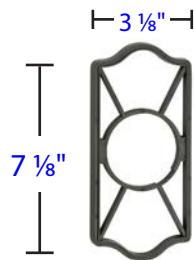

Adaptors available for leversets to fit doors between 1 3/8" and 1 5/8" thick.



Passage Function Shown in Passage Mode

Storeroom/Gate Function



- Storeroom / Gate Function**
- Outside lever always locked
 - Entry by code or key only
 - Inside lever always free



Passage Function in Locked Mode

- Outside lever always locked
- Entry by code or key only
- Inside lever always free



Passage Function in Passage Mode

- Outside lever always free
- Entry by operating lever, no code or key required.
- Inside lever always free

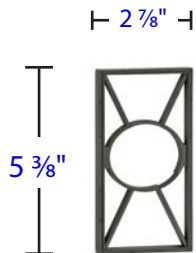
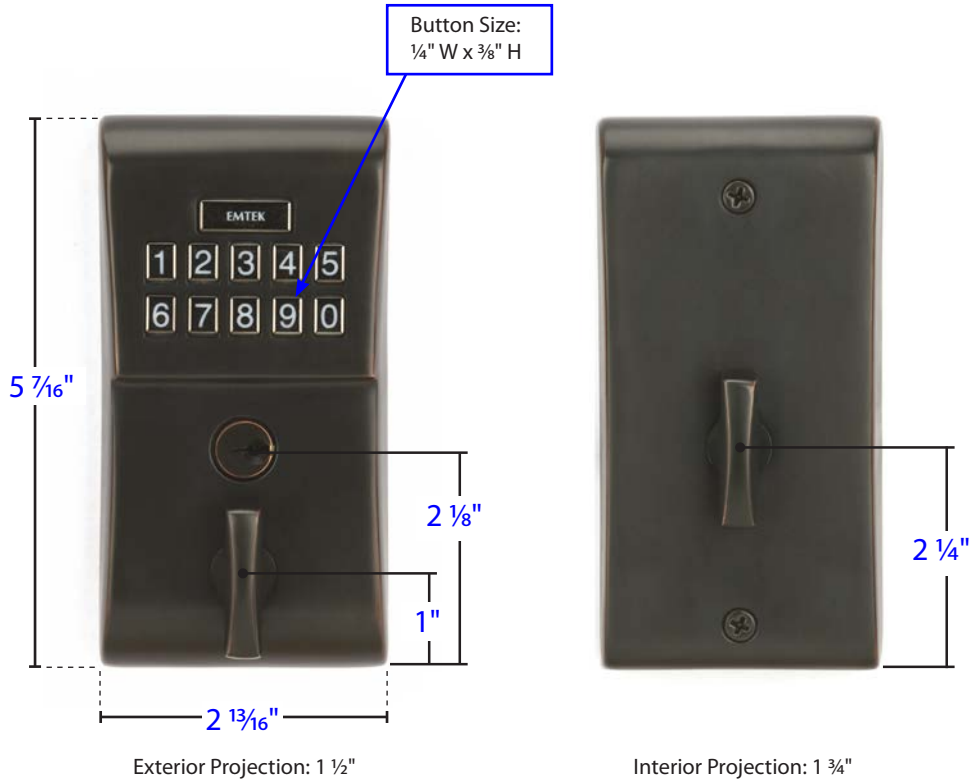

Adaptors available for deadbolts to fit doors between 1 3/8" and 1 5/8" thick.

Product Features:

- Fits any door between 1 3/4" to 2 1/4" thick with a 2 7/8" bore standard door prep.
- Installs easily with only a Phillips head screwdriver.
- Easy to use installation and programming instructions included.
- Factory programmed with 2 unique, secure user codes for use right out of the box.
- Can be programmed with up to 20 user codes of your choice.
- Codes can be added and deleted.
- Easy lock operation, simply push the Emtek button and turn the exterior thumb turn to lock.
- Easy unlock operation, enter the 4 digit code and turn the exterior thumb turn.
- Programming changes can be made easily using the keypad.
- Sleek keypad has a protective coating to prevent wear patterns.
- Illuminated keypad for easy and quick operation after dark.
- Low battery indicator lets you know when it's time to change the battery.
- Emtek's standard mechanical and finish warranties along with a 2 year warranty on electronic components.

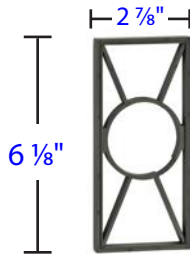
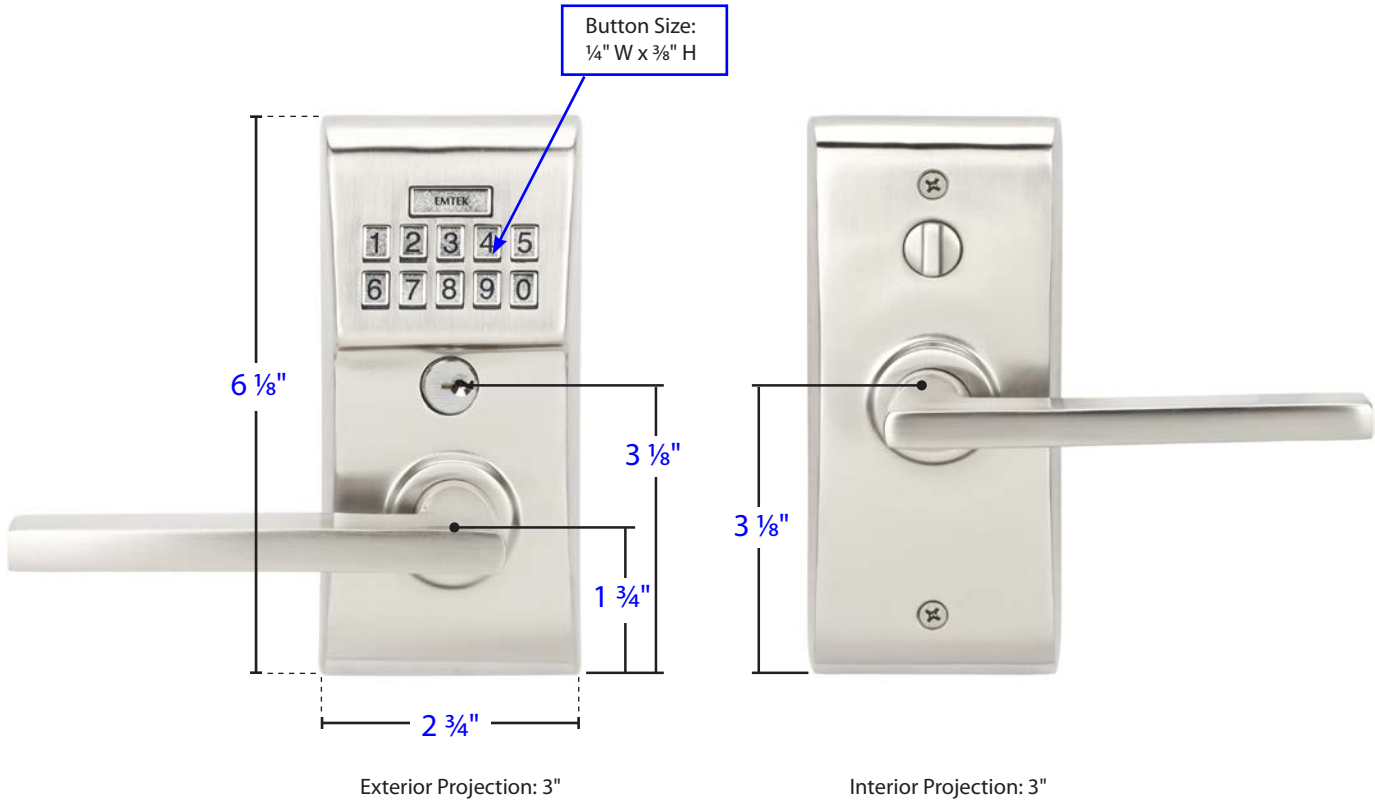

Adaptors available for leversets to fit doors between 1 ⅜" and 1 ⅝" thick.



Passage Function
Shown in Passage
Mode

Storeroom/Gate
Function



- Storeroom / Gate Function**
- Outside lever always locked
 - Entry by code or key only
 - Inside lever always free



- Passage Function in Locked Mode**
- Outside lever always locked
 - Entry by code or key only
 - Inside lever always free



- Passage Function in Passage Mode**
- Outside lever always free
 - Entry by operating lever, no code or key required.
 - Inside lever always free

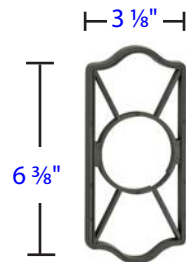
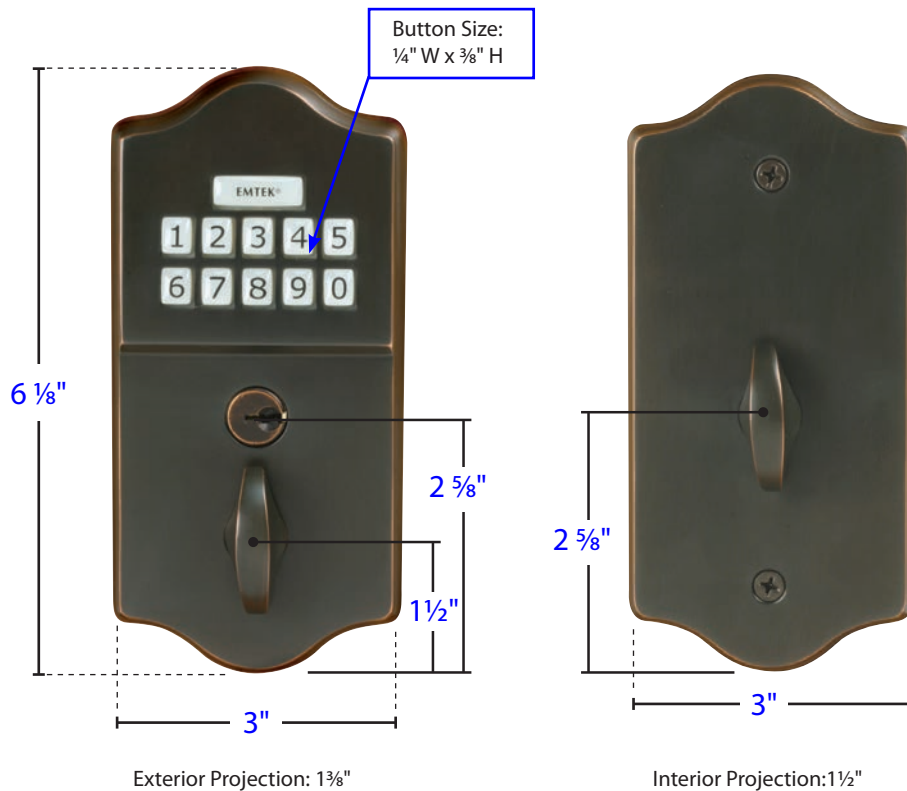

Adaptors available for deadbolts to fit doors between 1 3/8" and 1 5/8" thick.

Product Features:

- Fits any door between 1 3/4" to 2 1/4" thick with a 2 1/8" bore standard door prep.
- Installs easily with only a Phillips head screwdriver.
- Easy to use installation and programming instructions included.
- Factory programmed with 2 unique, secure user codes for use right out of the box.
- Can be programmed with up to 20 user codes of your choice.
- Codes can be added and deleted.
- Easy lock operation, simply push the Emtek button and turn the exterior thumb turn to lock.
- Easy unlock operation, enter the 4 digit code and turn the exterior thumb turn.
- Programming changes can be made easily using the keypad.
- Keypad has a protective coating to prevent wear patterns.
- Illuminated keypad for easy and quick operation after dark.
- Low battery indicator lets you know when it's time to change the battery.
- Emtek's standard mechanical and finish warranties along with a 2 year warranty on electronic components.

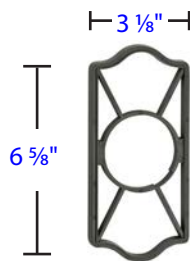
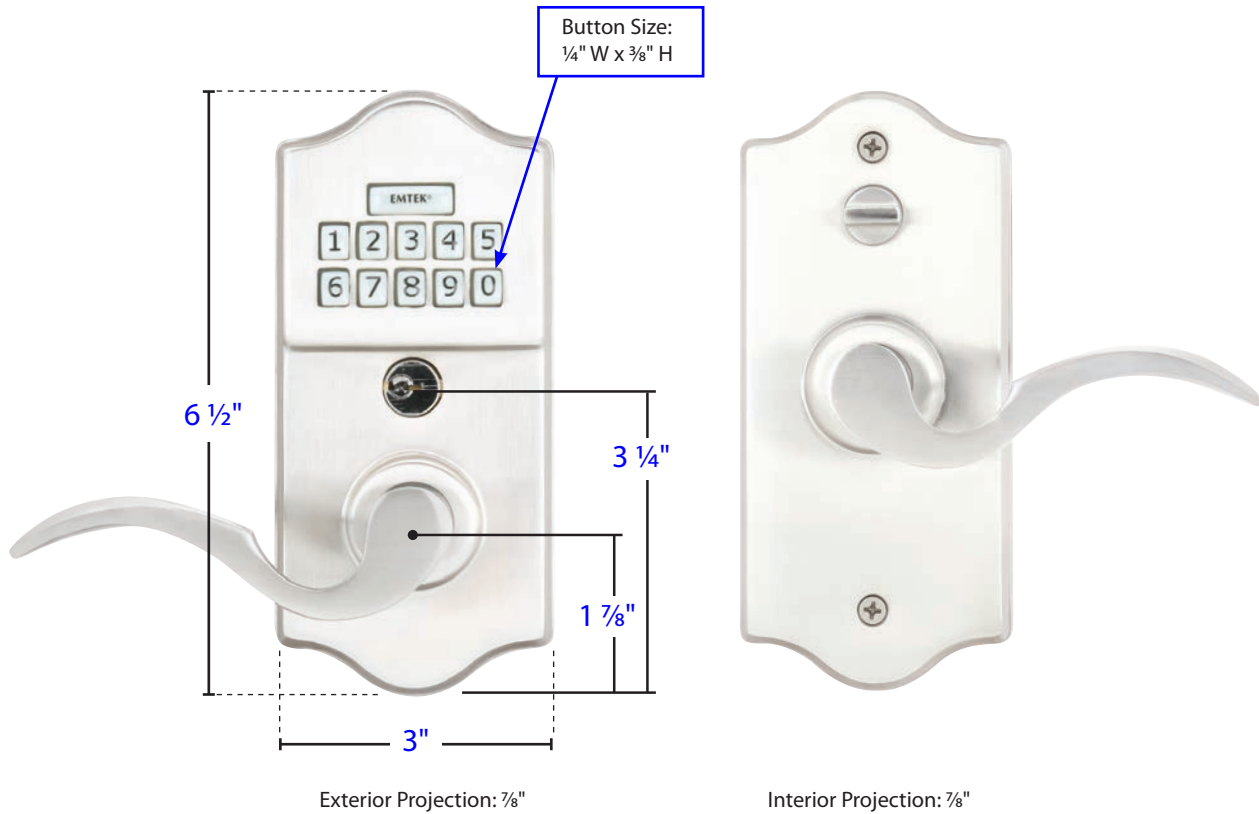

Adaptors available for leversets to fit doors between 1 3/8" and 1 5/8" thick.

Product Features for both Deadbolt & Lever Locksets:

- Fits any door between 1 3/4" to 2 1/4" thick with a 2 1/8" bore standard door prep.
- Installs easily with only a Phillips head screwdriver.
- Easy to use installation and programming instructions included.
- Factory programmed with 2 unique, secure user codes for use right out of the box.
- Can be programmed with up to 20 user codes of your choice.
- Programming changes can be made easily using the keypad.
- Keypad has a protective coating to prevent wear patterns.
- Illuminated keypad for easy and quick operation after dark.
- Low battery indicator lets you know when it's time to change the battery.
- Emtek's standard mechanical and finish warranties along with a 2 year warranty on electronic components.

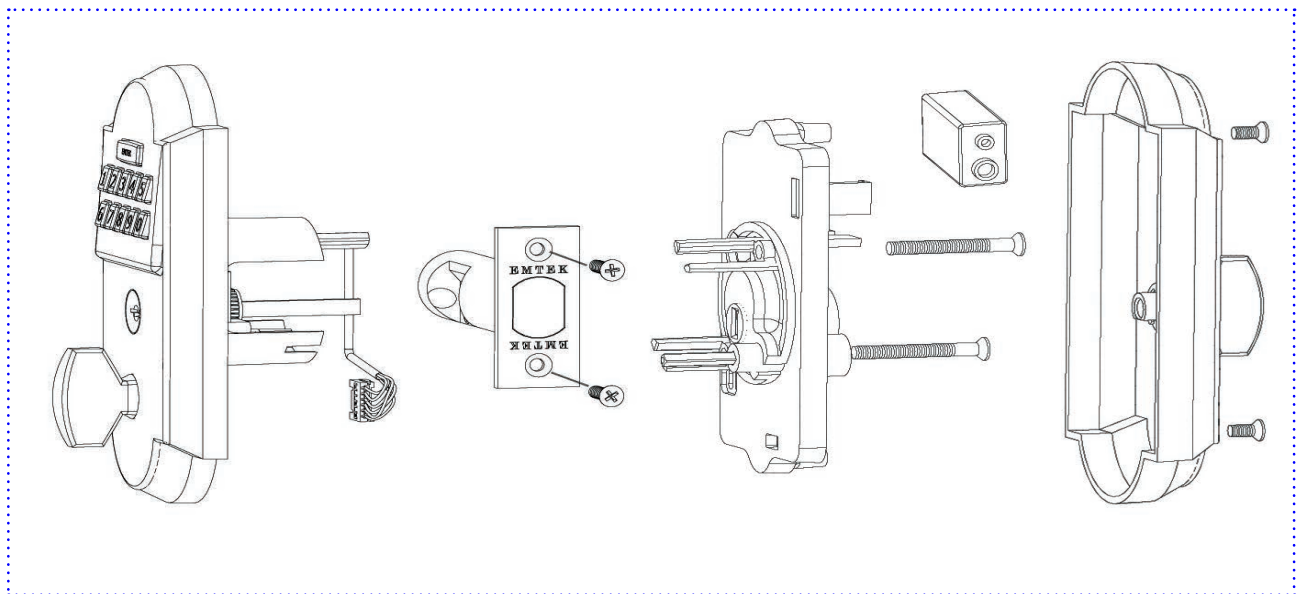
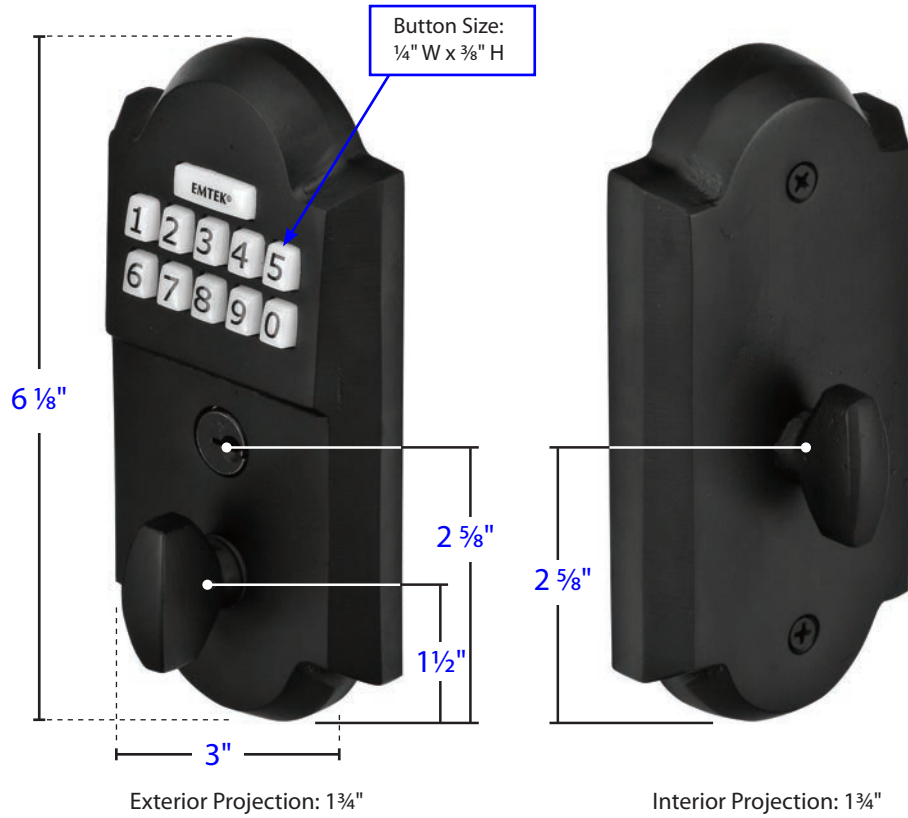

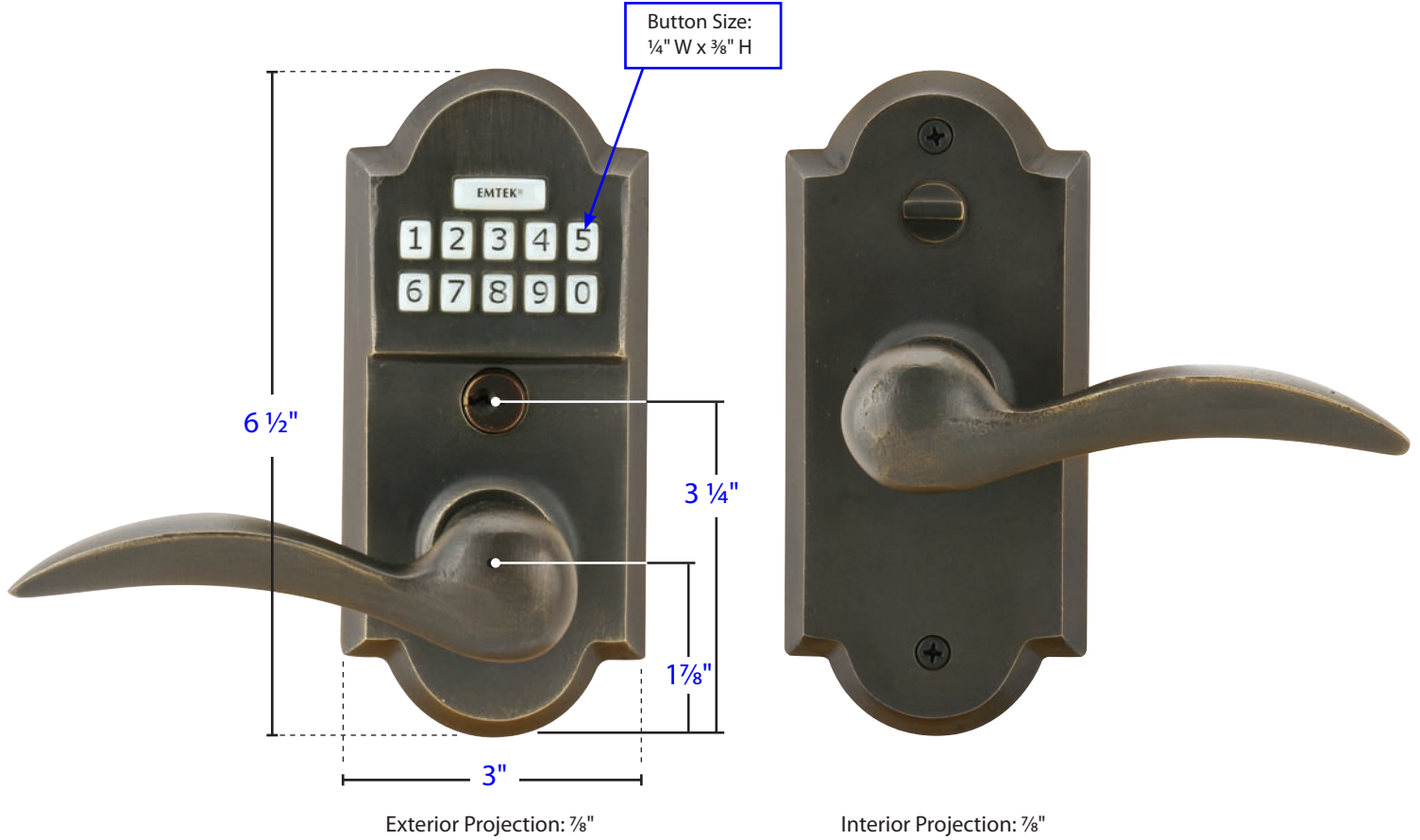

		<p>Locked</p> <ul style="list-style-type: none"> • Outside lever always locked • Entry by code or key only • Inside lever always free
<p>Storeroom / Gate Function</p> <ul style="list-style-type: none"> • Outside lever always locked • Entry by code or key only • Inside lever always free 		<p>Passage</p> <ul style="list-style-type: none"> • Outside lever always free • Entry by operating lever, no code or key required. • Inside lever always free

EMTouch™, Modern, Classic Keypad Locks Deadbolt

<p>• Standard Door Thickness: 1³/₄" - 2¹/₄"</p> <p>Standard Components:</p> <ul style="list-style-type: none"> • 8-32 x 1¹/₂" Mounting Screws • Schlage Cylinder w/ 1¹/₂" Tailpiece • Deadbolt Strike Plate 	<p>• Narrow Door Thickness: 1³/₈" - 1⁵/₈"</p> <p>Narrow Components:</p> <ul style="list-style-type: none"> • Extension Plate** <p>**Extension Plate is not available with bronze trim</p>	<p>• Extended Door Thickness: Greater than 2¹/₄"</p> <p>Extended Components:</p> <ul style="list-style-type: none"> • Not Available
--------------------------------------------------------------------------------------------------------------------------------------------------------------------------------------------------------------------------------------------------------------------------------------------------------------------------------------	-------------------------------------------------------------------------------------------------------------------------------------------------------------------------------------------------------------------------------------------------------------	---------------------------------------------------------------------------------------------------------------------------------------------------------------------------------

EMTouch™, Modern, Classic Keypad Locks Leverset

<p>• Standard Door Thickness: 1³/₄" - 2¹/₄"</p> <p>Standard Components:</p> <ul style="list-style-type: none"> • 8-32 x 1¹/₂" Mounting Screws • Schlage Cylinder w/ 3/8" Lever Lock Tailpiece • Full-Lip Strike Plate* <p>*Extended Full Lip Strike Plate is used on doors greater than 2" thick</p>	<p>• Narrow Door Thickness: 1³/₈" - 1⁵/₈"</p> <p>Narrow Components:</p> <ul style="list-style-type: none"> • Extension Plate** <p>**Extension Plate is not available with bronze trim</p>	<p>• Extended Door Thickness: Greater than 2¹/₄"</p> <p>Extended Components:</p> <ul style="list-style-type: none"> • Not Available
---------------------------------------------------------------------------------------------------------------------------------------------------------------------------------------------------------------------------------------------------------------------------------------------------------------------------------------------------------------------------------------------------------	-------------------------------------------------------------------------------------------------------------------------------------------------------------------------------------------------------------------------------------------------------------	---------------------------------------------------------------------------------------------------------------------------------------------------------------------------------