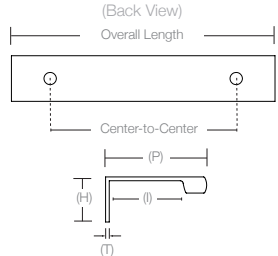
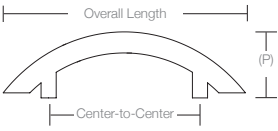
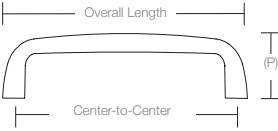
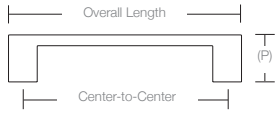

Contemporary Cabinet Knob & Pull Specifications

Edge Pull		Product Code	Dimension C-to-C	Overall Length	Projection(P)	Height(H)	Inner Projection(I)	Thickness(T)
		87160	1"	1 1/2"	1 3/4"	3/4"	1 1/4"	1/16"
87100	3"	4 1/4"	1 3/4"	3/4"	1 1/4"	1/16"		
87110	4"	5 1/4"	1 3/4"	3/4"	1 1/4"	1/16"		
87120	6"	7 1/4"	1 3/4"	3/4"	1 1/4"	1/16"		
87130	8"	9 1/4"	1 3/4"	3/4"	1 1/4"	1/16"		
87140	10"	11 1/4"	1 3/4"	3/4"	1 1/4"	1/16"		
87150	12"	13 1/4"	1 3/4"	3/4"	1 1/4"	1/16"		

Arch Pull		Product Code	Dimension C-to-C	Overall Length	Projection(P)
		86153	3"	4 3/4"	1 1/8"
86154	3 1/2"	5 1/8"	1 1/8"		
86155	4"	5 5/8"	1 1/8"		
86251	6"	8 1/2"	1 1/4"		

Orbit Pull		Product Code	Dimension C-to-C	Overall Length	Projection(P)
		86256	3"	3 3/8"	1"
86257	3 1/2"	3 7/8"	1"		
86258	4"	4 3/8"	1"		
86259	6"	6 3/8"	1"		
86260	10"	10 7/16"	1"		

Trinity Pull		Product Code	Dimension C-to-C	Overall Length	Projection(P)	Width(W)
		86263	3"	3 1/2"	1"	5/8"
86264	3 1/2"	4"	1"	5/8"		
86265	4"	4 1/2"	1"	5/8"		
86482	5"	5 1/2"	1"	5/8"		
86266	6"	6 1/2"	1"	5/8"		
86438	8"	8 1/2"	1"	5/8"		
86267	10"	10 1/2"	1"			
86483	12"	12 1/2"	1"			
<i>Also available in Appliance Pulls:</i>						
86444	13"	12"	1 3/4"	1 5/16"		
86445	19"	18"	1 3/4"	1 5/16"		

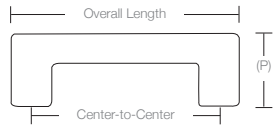
Trail Pull		Product Code	Dimension C-to-C	Overall Length	Projection(P)	Width(W)
		86161	3"	3 5/8"	1 3/8"	1/2"
86162	3 1/2"	4 1/8"	1 3/8"	1/2"		
86163	4"	4 5/8"	1 3/8"	1/2"		
86272	5"	5 3/4"	1 3/8"	1/2"		
86164	6"	6 5/8"	1 3/8"	1/2"		
86165	8"	8 5/8"	1 3/8"	1/2"		
86273	10"	10 6/8"	1 3/8"	1/2"		
86166	12"	12 5/8"	1 3/8"	1/2"		
86274	16"	16 5/8"	1 3/8"	1/2"		
<i>Also available in Appliance Pulls:</i>						
86440	13"	12"	2"	1 1/16"		
86441	19"	18"	2"	1 1/16"		

Globe Knob

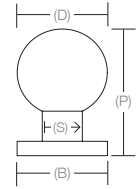
 <p>(Back Plate Included)</p>		Product Code Dimension(D) Projection(P) Base Diameter(B) Stem Diameter(S)
		86152 1 1/8" 1 1/2" 1" 1/2"

Finger Pull

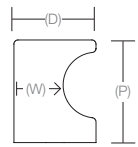
		Product Code Dimension(D) Projection(P) Width(W)
		86150 7/8" 1" 5/8" 86151 1" 1 1/4" 5/8"

Ring Knob

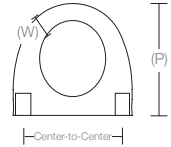
 <p>(2 Screws are Included)</p>		Product Code Dimension C-to-C Projection(P) Width(W)
		86270 1" 1 1/4" 3/8"

Cone Knob

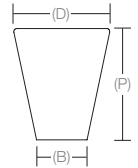
		Product Code Dimension(D) Projection(P) Base Diameter(B)
		86261 1" 1 1/8" 1/2" 86262 1 1/8" 1 3/8" 5/8"

Metric Knob

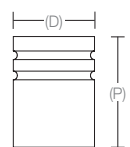
		Product Code Dimension(D) Projection(P)
		86268 1" 1 1/8" 86269 1 1/8" 1 3/8"

Trail Knob

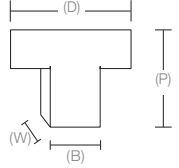
		Product Code Dimension(D) Projection(P) Base(B) Width(W)
		86271 2" 1 3/8" 3/8" 5/8"